



603063

/

5kW	8kW	8kW	33kW	36kW	50kW	60kW	125kW
DC1500V	225kW	350kW	WiFi	/GPRS	/4G		
1100V	500kW	630kW	800kW	1500V	2500kW	3125kW	
1100V	1000kW	1250kW		1MW	1.25MW	2MW	2.5MW
4MW	5MW	186kW	250kW				



CNAS



- 1500V 04
- 1100V 06
- 1100V 08
- 10
- 12
- 2.5MW 14
- 35kV/10kV 16
- 18
- 19
- 20
- 21

▶ 2.5MW/3.125MW

- 2.5MW 3.125MW
- MPPT 99.11%
- SVG MPPT
- 1500V 550V/600V/630V
- HVRT/LVRT 1500V
- IP55

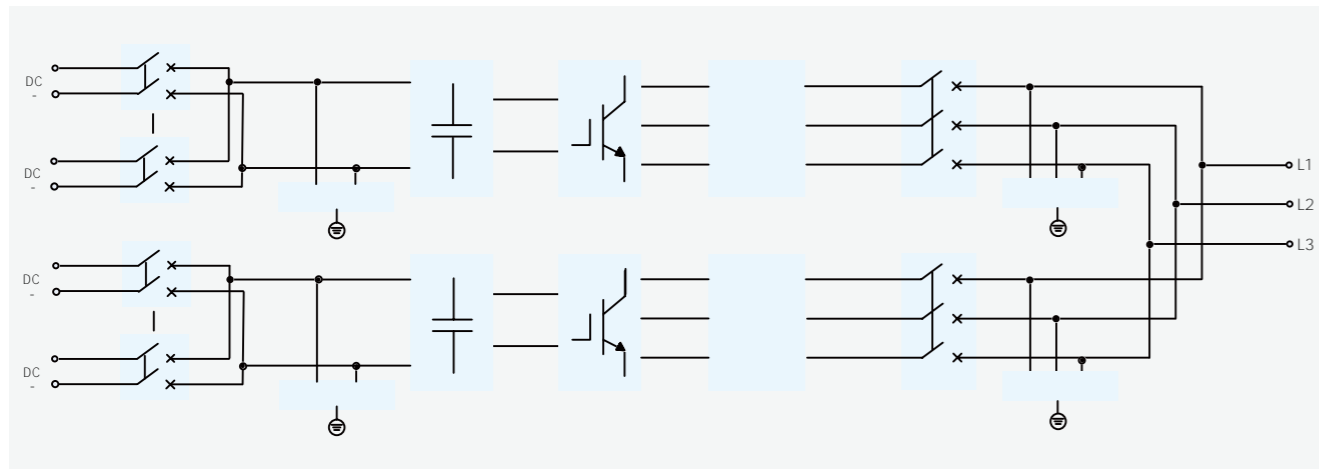

2500kW 3125kW/DC1500V

	HPHV2500-550	HPHV2500-630	HPHV3125-550	HPHV3125-600	HPHV3125-630
MPPT	800V 1450V				
	1500V				
	12	24	/ 18	16	14 24 / 22 16
	400A				
	2500kW		3125kW		
	2750kW		3438kW		
	2624A	2292A	3280A	3008A	2864A
	2886A	2522A	3608A	3309A	3150A
	550V	630V	550V	600V	630V
	440V 632V	504V 724V	440V 632V	480V 690V	504V 724V
	50Hz / 60Hz				
	±3Hz				
THD	3%				
	0.5%				
	0.8		0.8		
	99.02%	99.04%	99.01%	99.11%	
	98.49%		98.62%		
	100W				
	IP55				
	40	55	40		
	40		70		
	5000m	4000m			
	0%		95%		
	RS485 Ethernet				
* *	1710*2505*1700mm				
	2700kg				

4000m



-
-
-
- MPPT
-
- IGBT
- 220V
-
-
-
-
-
-
- IP55

IGBT
220V

UPS

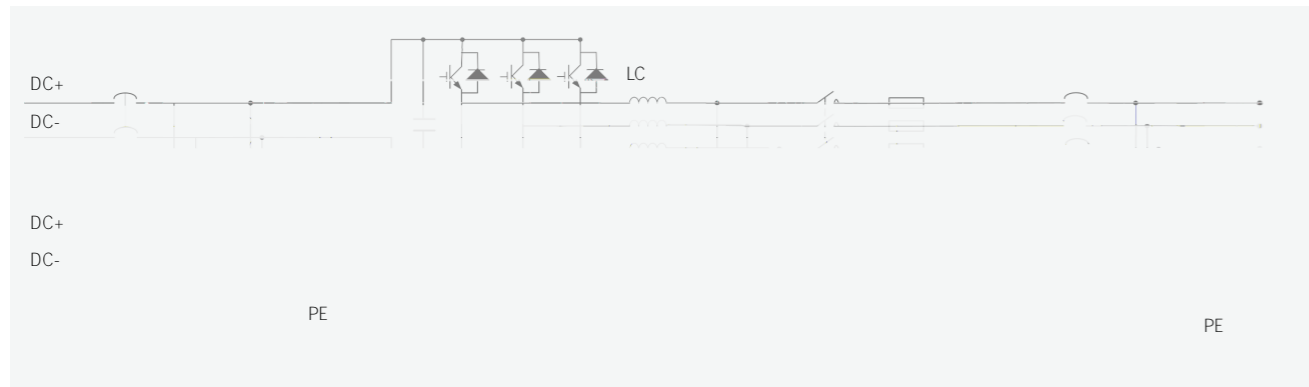

500kW 630kW 800kW/DC1100V

	HPSP0500	HPSP0630		HPSP0800-CC	
MPPT	500V 900V	520V 900V		500V 900V	
	1100V				
	8			12	
	160A				
	500kW	630kW		800kW	
	550kW	693kW		840kW	
	902A	1137A	1010A		1320A
	993A	1250A	1111A		1386A
	320V	320V	360V		350V
	256V 368V	256V 368V	288V 414V		315V 385V
	50Hz / 60Hz				
	±3Hz				
THD	3%				
	0.5%				
	0.9	0.9	0.95		0.95
	99.02%	99.01%	99.03%		99.01%
	98.3%	98.3%	98.4%		98.5%
	50W				
	IP20 / IP55				
	40 55		40		
	40		70		
	5000m		4000m		
	5%		95%		
	RS485 Ethernet				
* *	1000*2150*800mm / 1220*2300*870mm				
	1000kg				

4000m 270V 315V 360V 380V

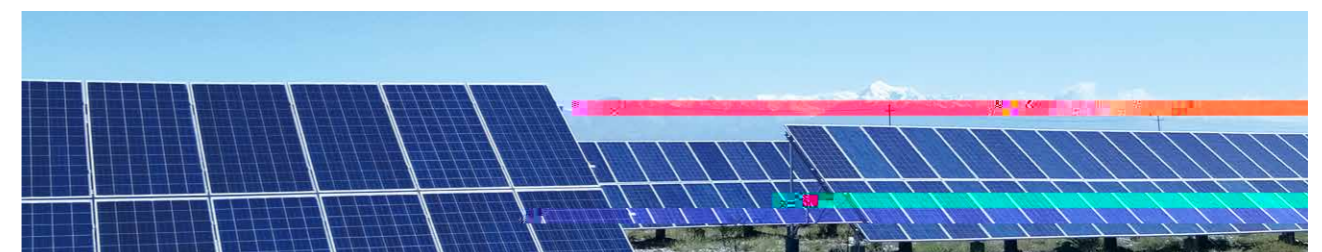



MPPT

2 PV

1 MPPT

DC/DC

MPPT

2 PV

1 MPPT

1MW

80 128 MPPT MPPT

800V

520V

1100V

1500V

10

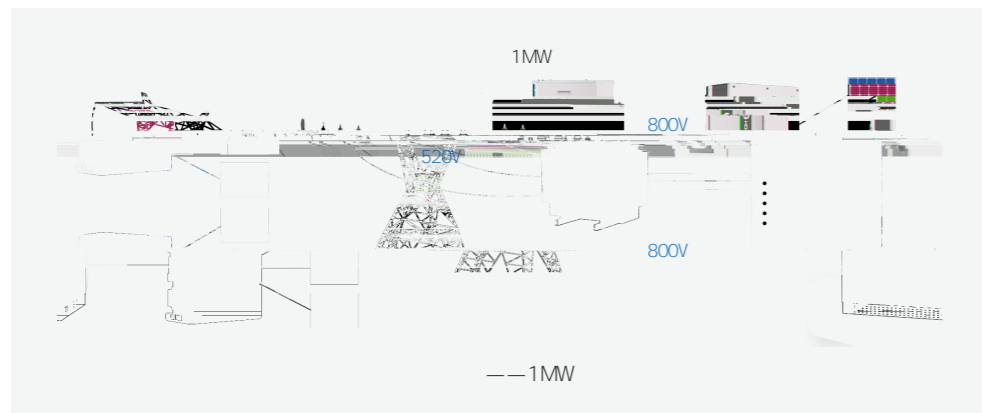

RS485

Ethernet RS485

RS485

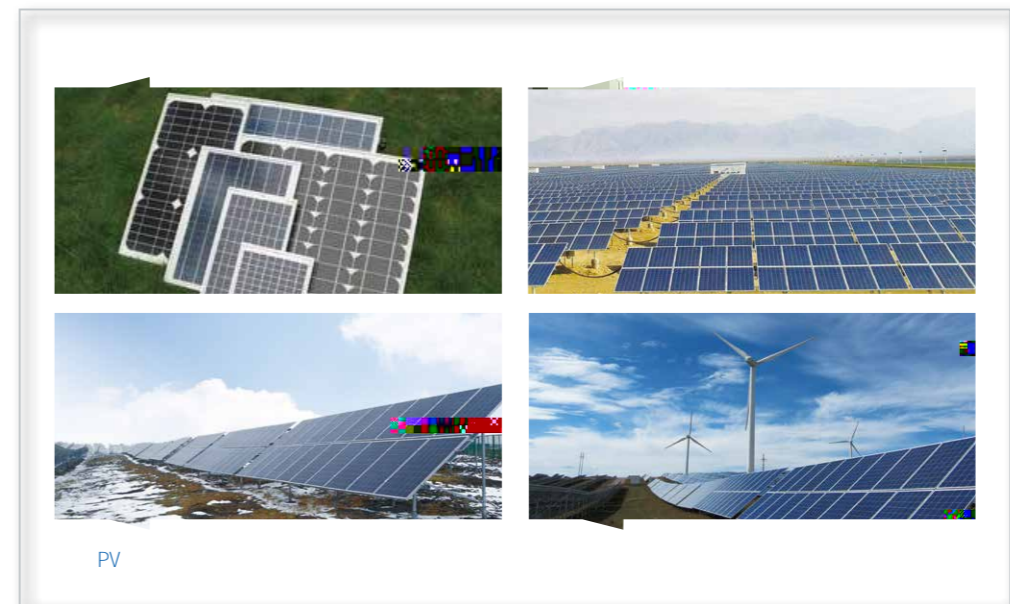
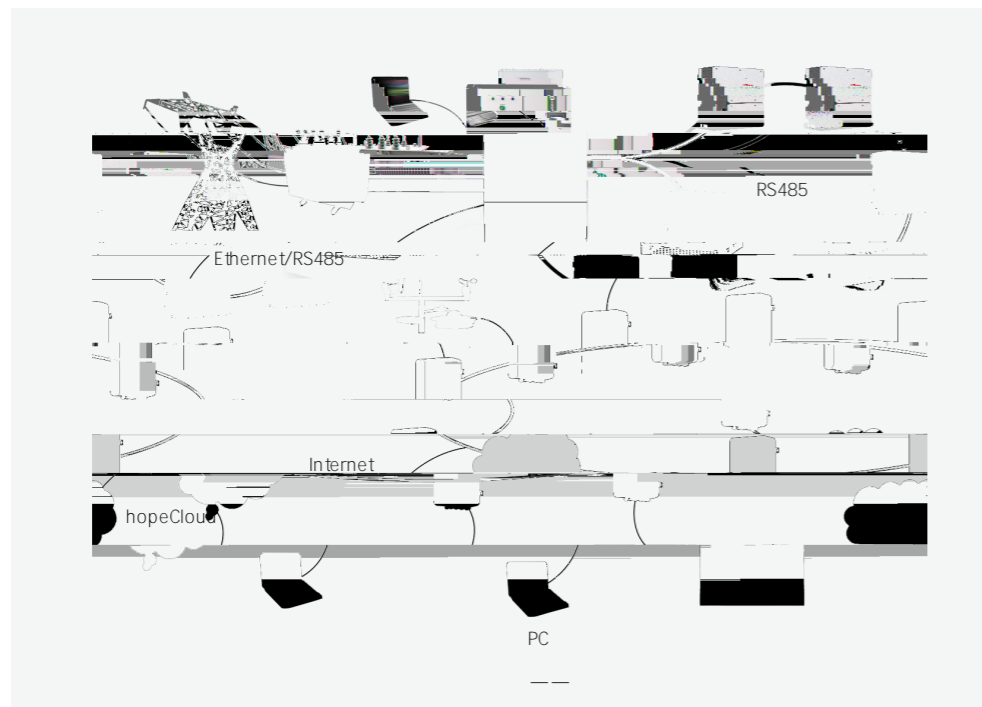

500V 800V

800V

270V/315V

520V

1MW

500kW

500kW

1MW

	270V/315V	520V	0.2% ↑
	500V 800V	800V	0.4% ↑
	500kW*2	1MW*1	0.8% ↑
Total			1.4% ↑



1%

- MPPT
- IP65
- PV
- 2 PV 1 MPPT
- DC/DC

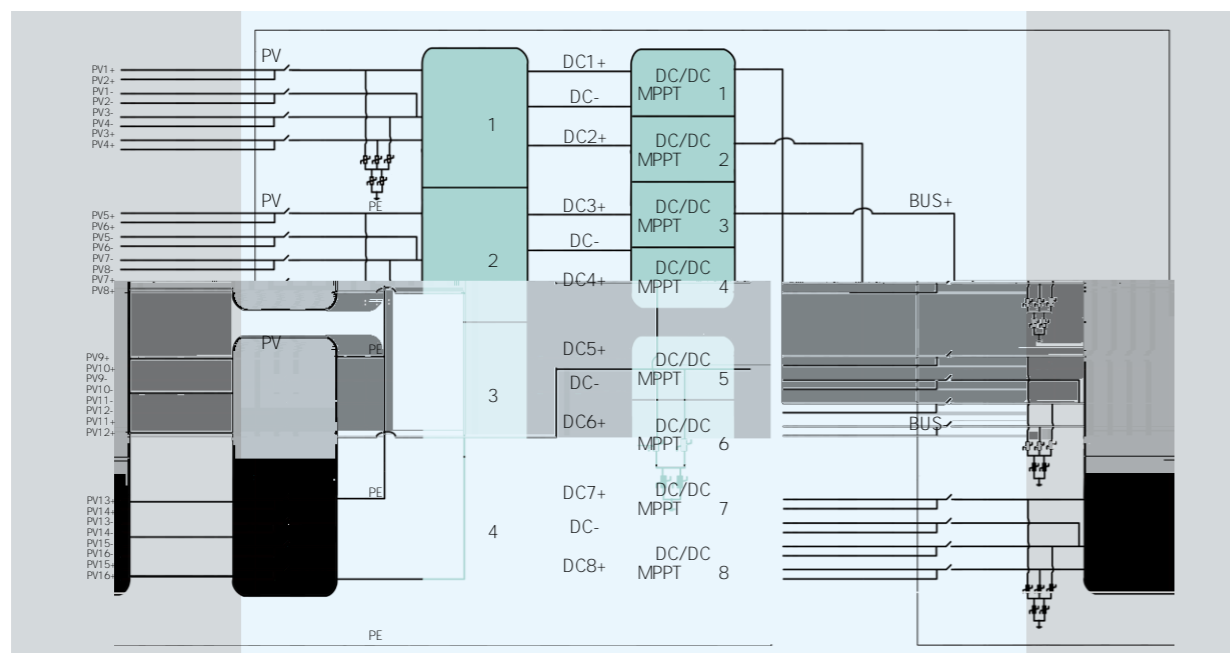

	HPPCU160-16-D	HPPCU160-16	HPPCU120-12	HPPCU80-8
	1100V			
MPPT	300V 850V			
	16		12	8
	12A	9A		
	13A	10A		
	800V			
	165A	120A	90A	60A
	181.5A	132A	99A	72A
	99.7%	99.7%	99.6%	99.5%
	99.6%	99.6%	99.5%	99.4%
MPPT	8	8	6	4
	IP65			
		40	55	
		40	70	
		5%	95%	
	RS485			
	* *	550*530*280mm	550*530*280mm	550*530*280mm
		42kg	40kg	30kg

-D



PV 22 30 2 1.25MW 1 2500kVA

800Vdc

1.5

2/3

/

4/9

70mm²

9/4

1.25MW

35mm²

1.25MW

1.5

1.25MW

2/3

70mm²

2.5MW

50mm²

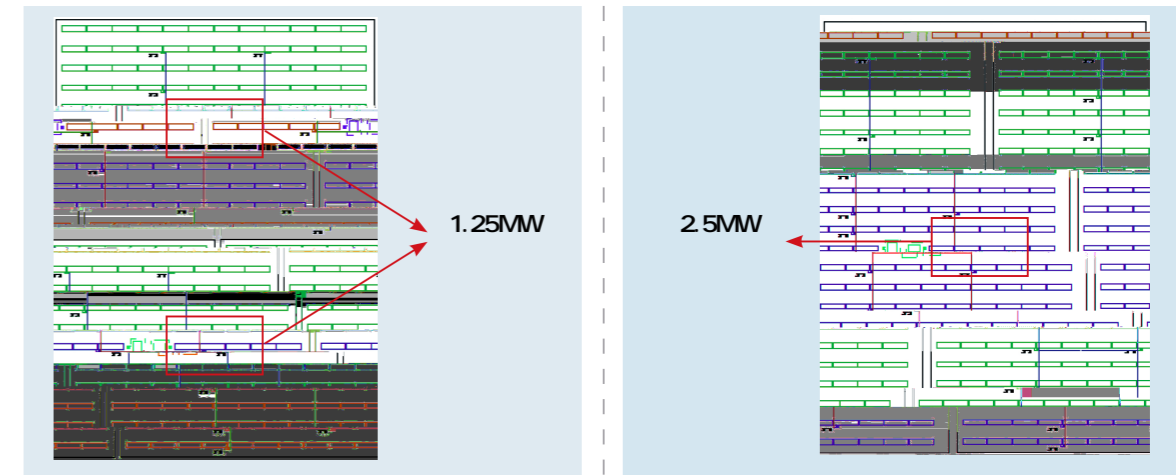
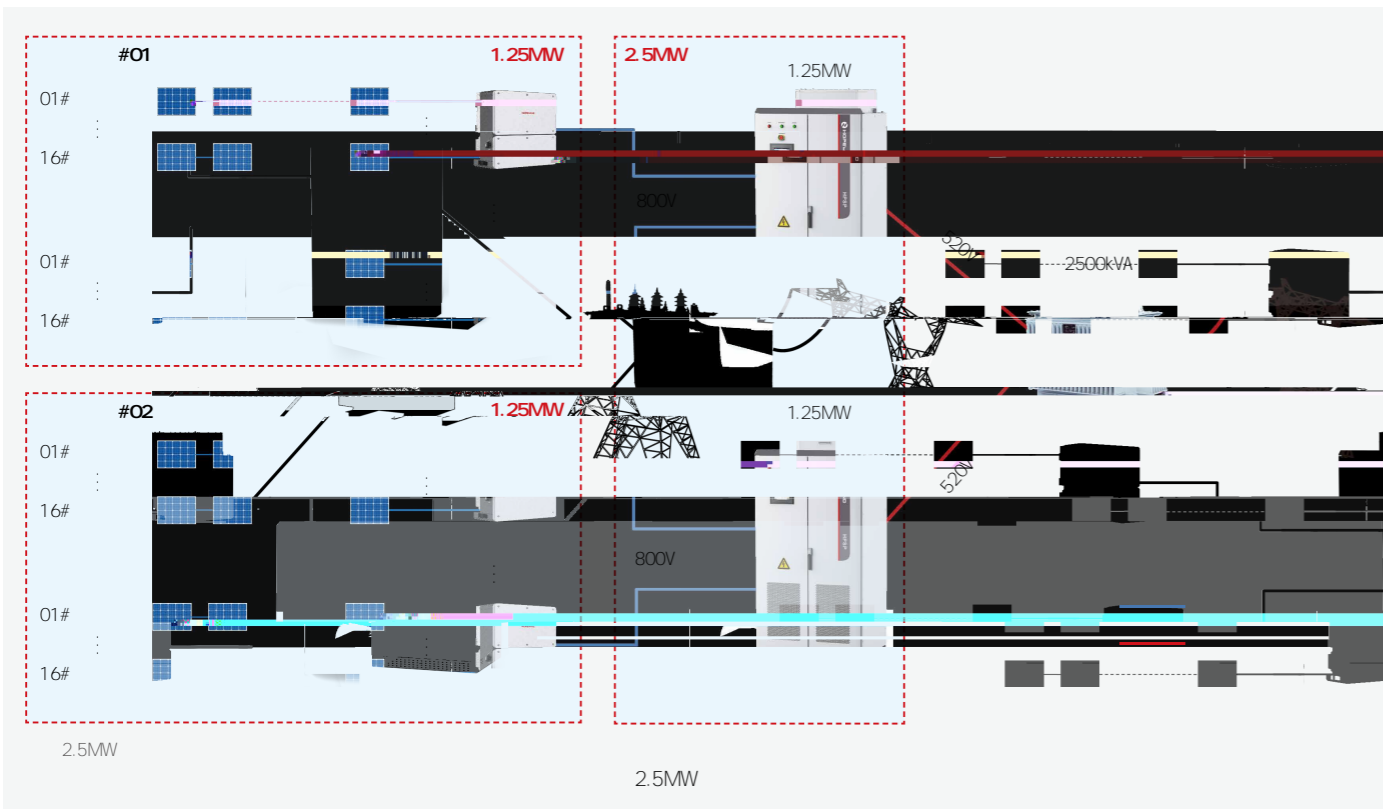

2 1.25MW

2.5MW

5.6 /W

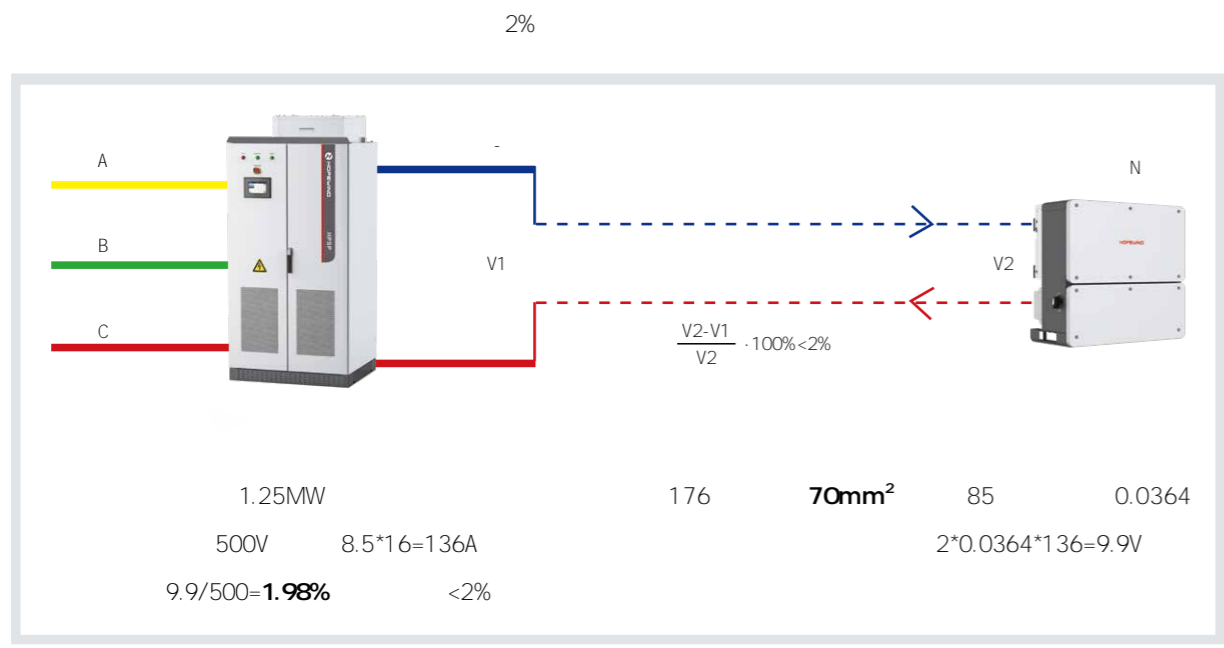

		AC		DC			/W	
2.5MW 1.25MW	2	-1.0	-11.0	-3.0	+6.0	-2.0	-3.0	5.6
		14						





1

AC

2

20

3

MW

AC

25%



		HPPS1000-G HPPS1250-G	HPPS1562.5-G HPPS2000-G	HPPS2500-G HPPS3125-G HPPS4000-G	HPPS5000-G HPPS6250-G
		HPPS1000-Y HPPS1250-Y	HPPS1562.5-Y HPPS2000-Y	HPPS2500-Y HPPS3125-Y HPPS4000-Y	HPPS5000-Y HPPS6250-Y
		1MW / 1.25MW	1.5625MW / 2MW	2.5MW / 3.125MW / 4MW	5MW / 6.25MW
		320V / 360V / 520V / 550V / 600V / 630V			550V / 600V / 630V
		10kV / 35kV			
		/			
	CT PT				
35kV * *		5000*2600*2500mm		9000*2800*2600mm	
		3900*2600*2500mm		7800*2800*2600mm	
		11000kg	16000kg	18000kg	
		8500kg	13000kg	14000kg	

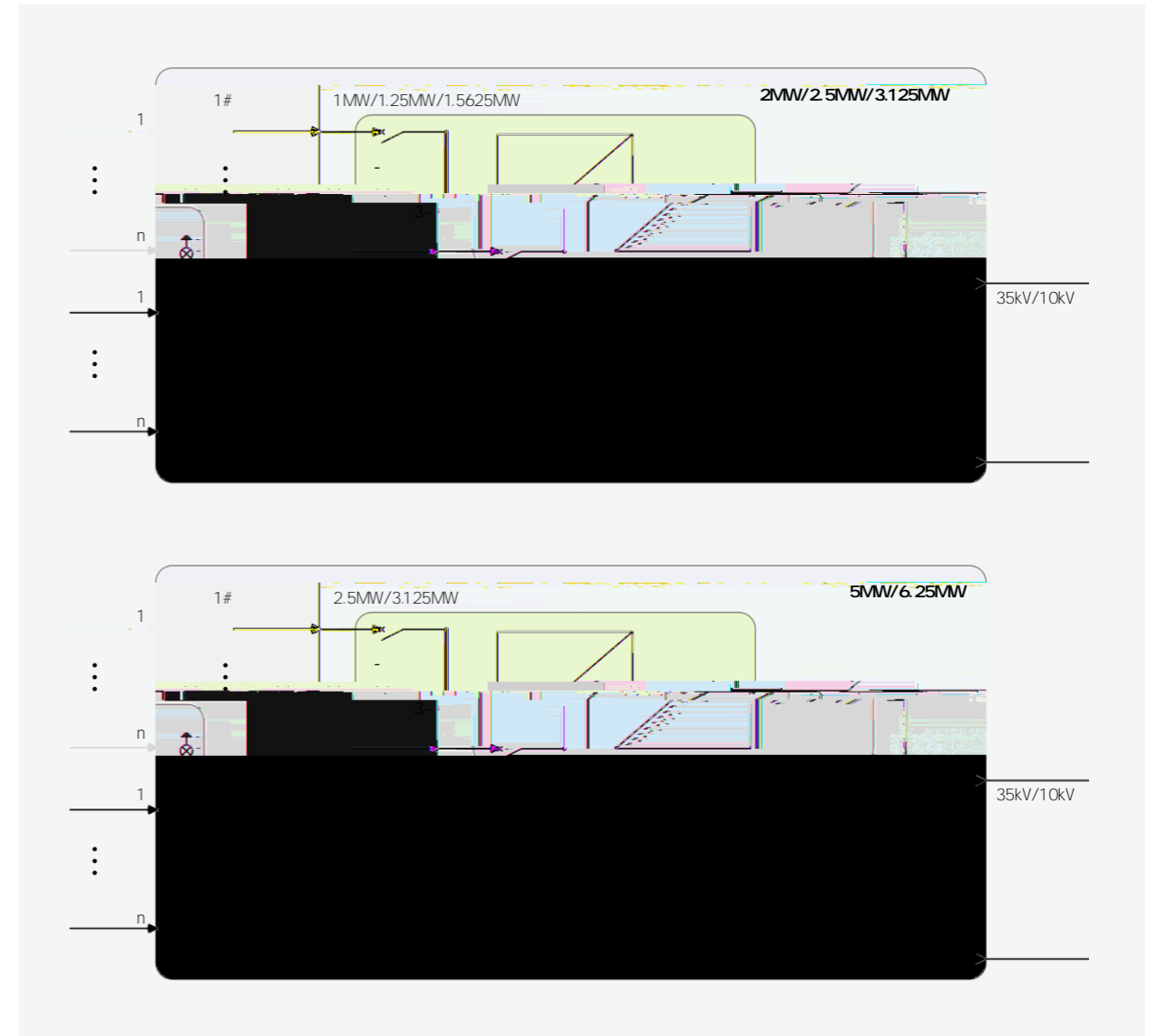

- Linux
- AGC AVC
- Web
- 512MB DDR
- RS485
- IEC104 Modbus-TCP Modbus-RTU Goose MMS

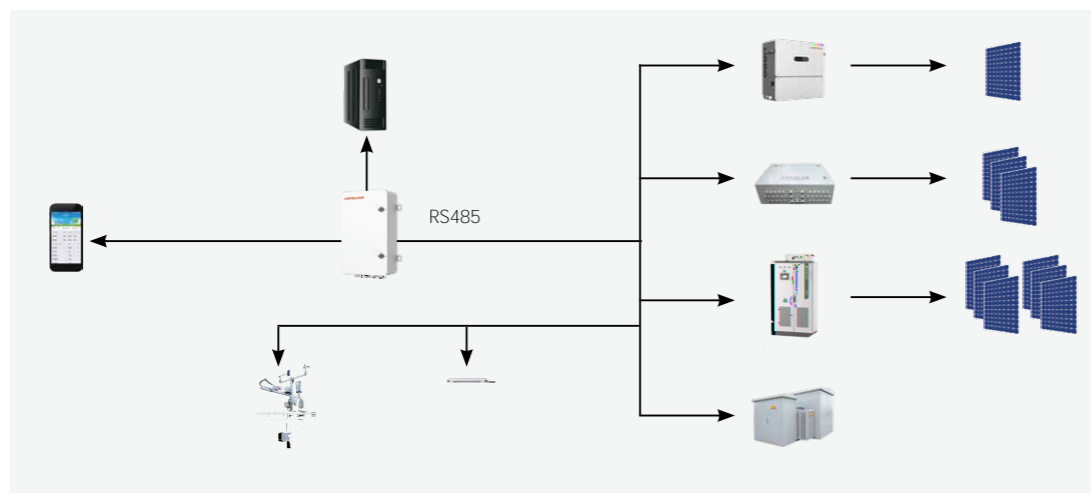

hopeComBox3000-D03	
	120
	RS485 RJ45 SFP
	2 3
	4 24 SC
RS485	COM×8
	ETH×2
	SFP×2
	220VAC 50/60Hz
	L+N+PE
	-40 +65
	-40 +70
	5-95%
	4000m
	IP65
* *	430*670*175mm
	15kg

±10mm

- IP54



	DC1100V	DC1100V	DC1500V
* *	1500*2500*1100mm	1500*2500*2438mm	2100*2523*2438mm
	2000kg	3000kg	4500kg

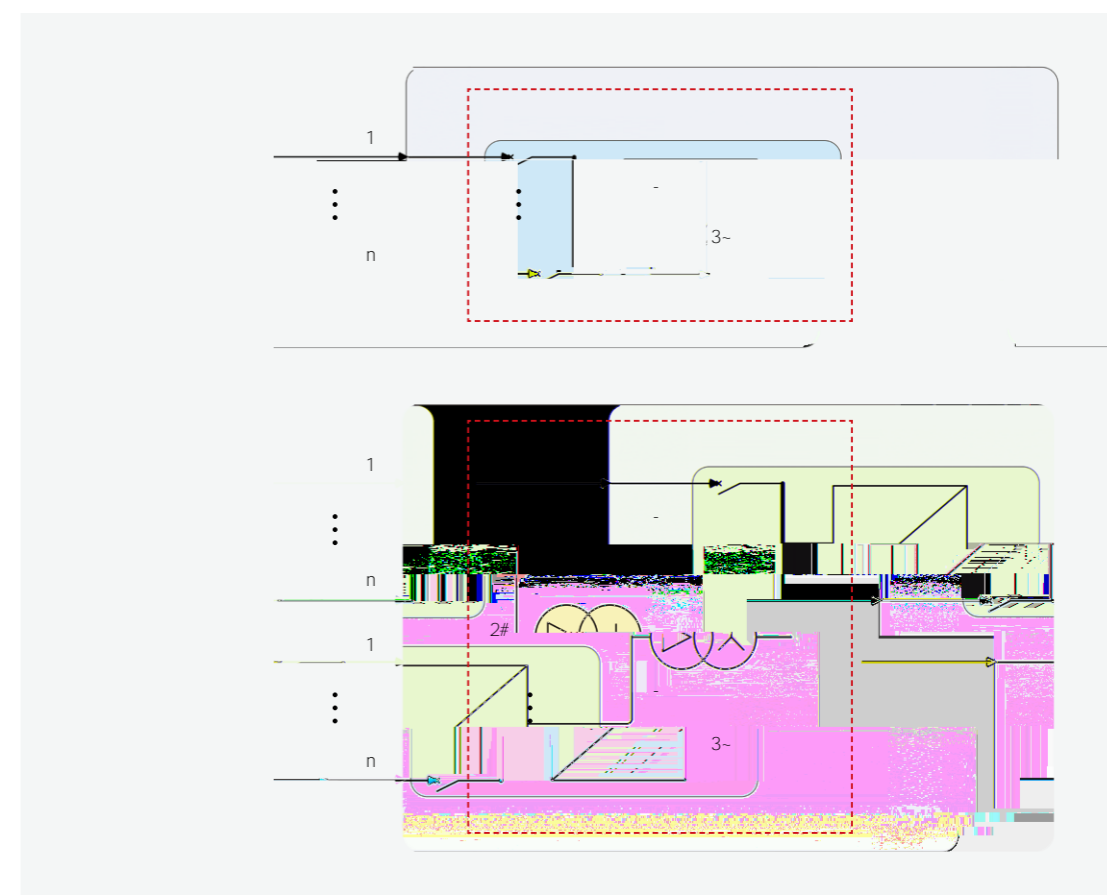

PV

RS485

DC/DC

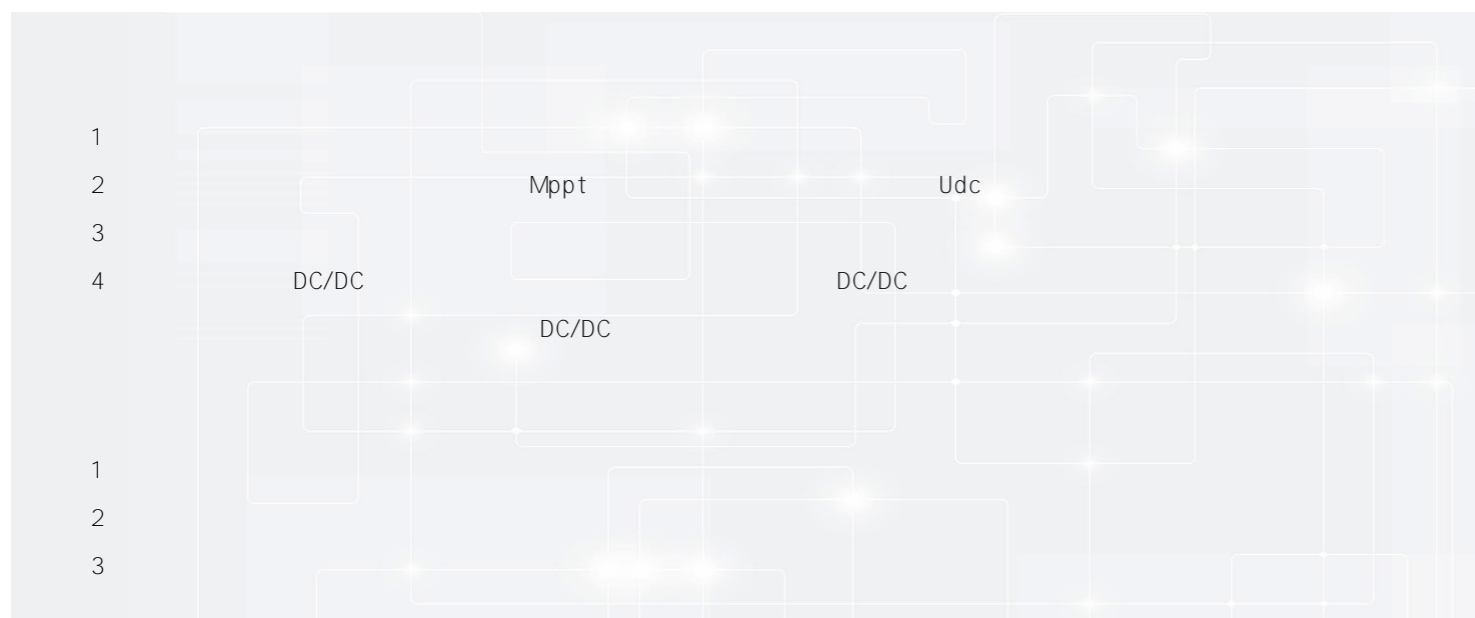
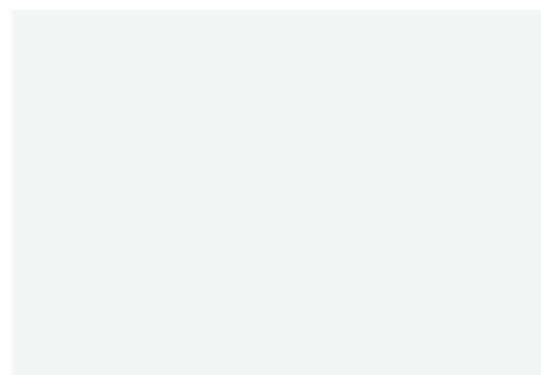
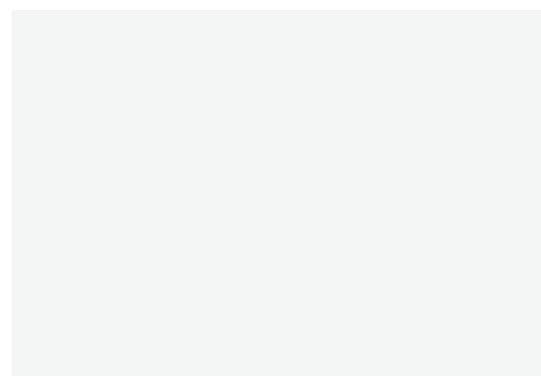
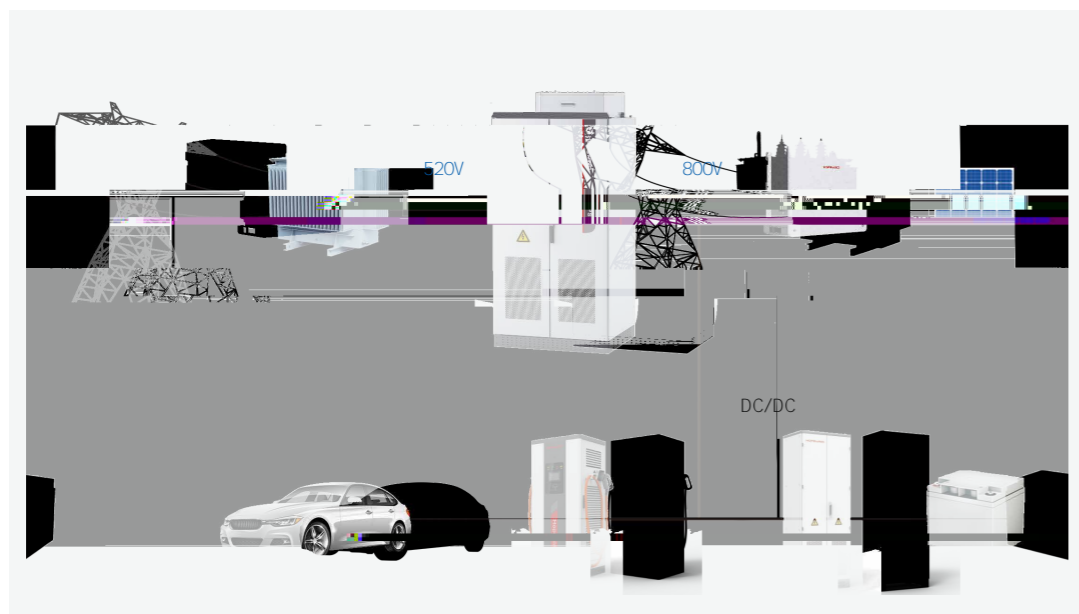

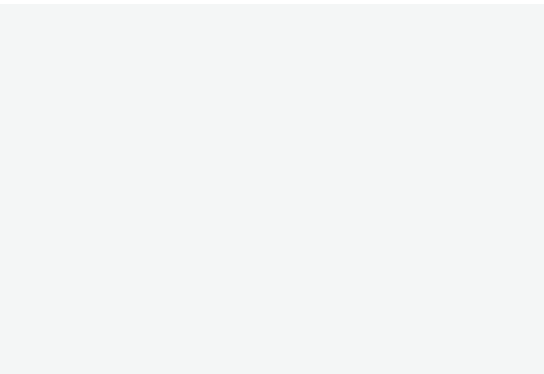
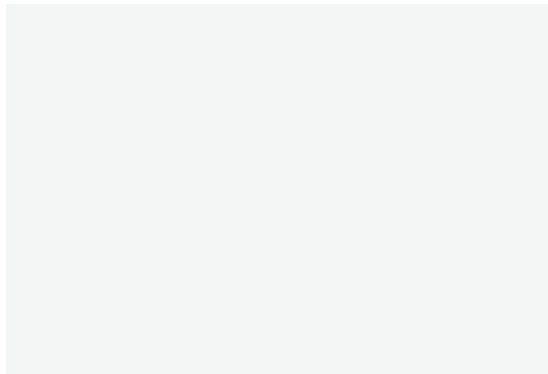
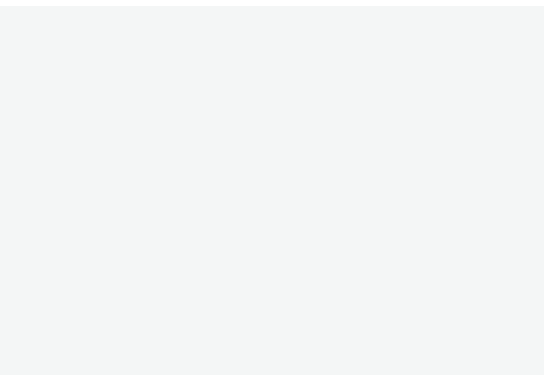
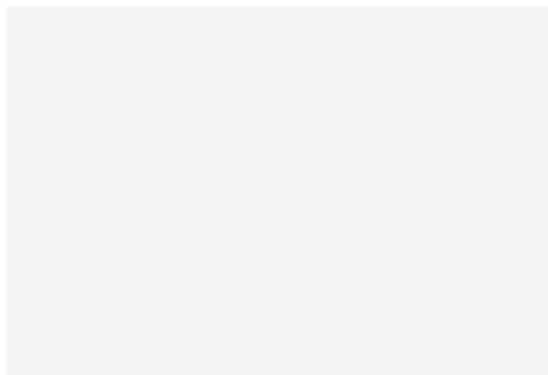
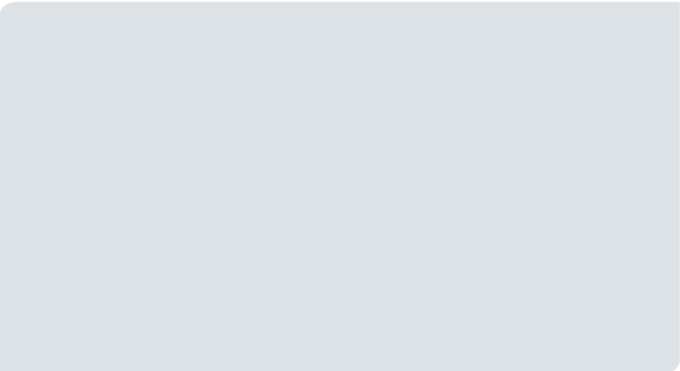

风禾尽起 志望千里



400-018-5881

+86-755-86026786

www.hopewind.com